



MKH 8030

- Quick Guide
- Kurzanleitung
- Guide rapide
- Guida rapida
- Guía de inicio rápido
- Guia rápido
- Beknopte handleiding
- Krótká instrukcja obsługi
- Snabbguide
- Kort vejledning
- Pikaohje
- Γρήγορος οδηγός
- Kisa Kilavuz
- Краткая инструкция
- 快速指南
- 快速使用指南
- クイックガイド
- 퀵 가이드

SENNHEISER

Sennheiser electronic SE & Co. KG
 Am Labor 1, 30900 Wedemark, Germany
 www.sennheiser.com
 Printed in Germany, Publ. 03/24, 597231/A02

In the box

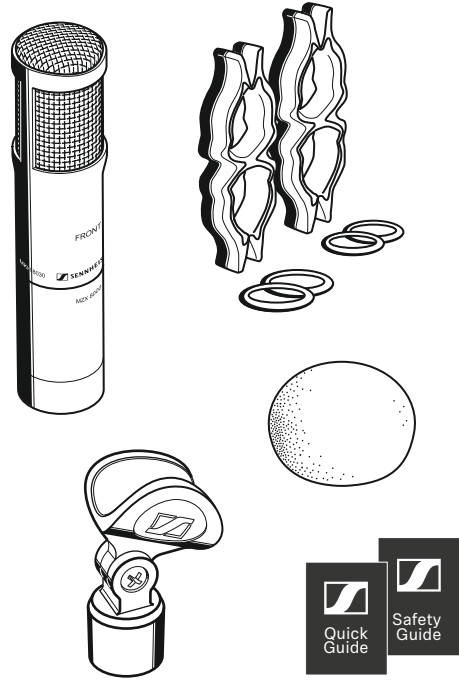

Overview



- 1 Microphone head
- 2 XLR-Modul

Setup

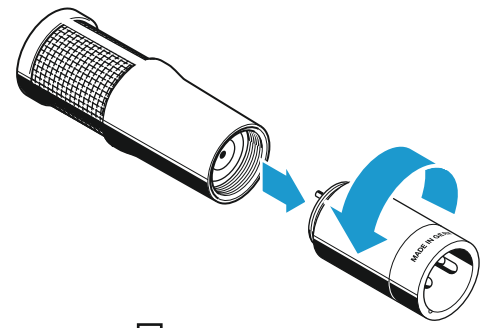

i See MKH 8000 series microphone and accessories overview

Setup

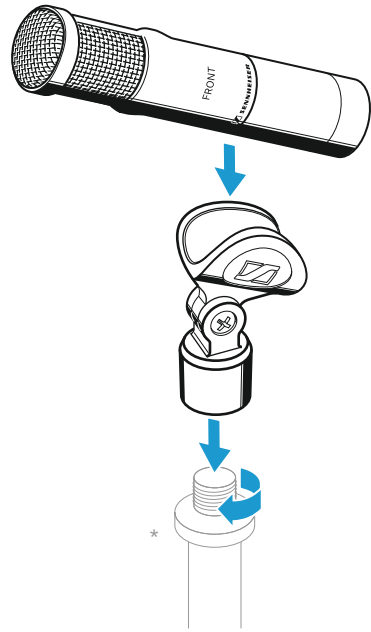

* not included

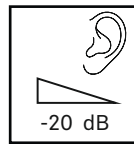
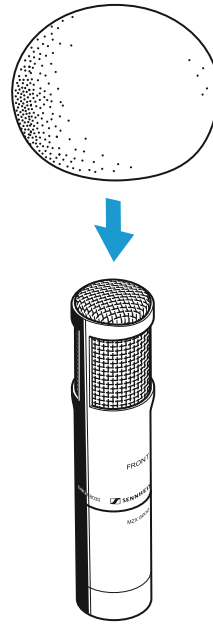

Cleaning

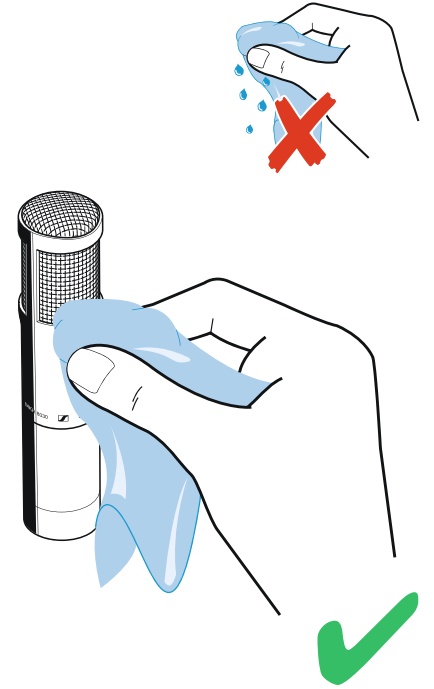

Stereo recording

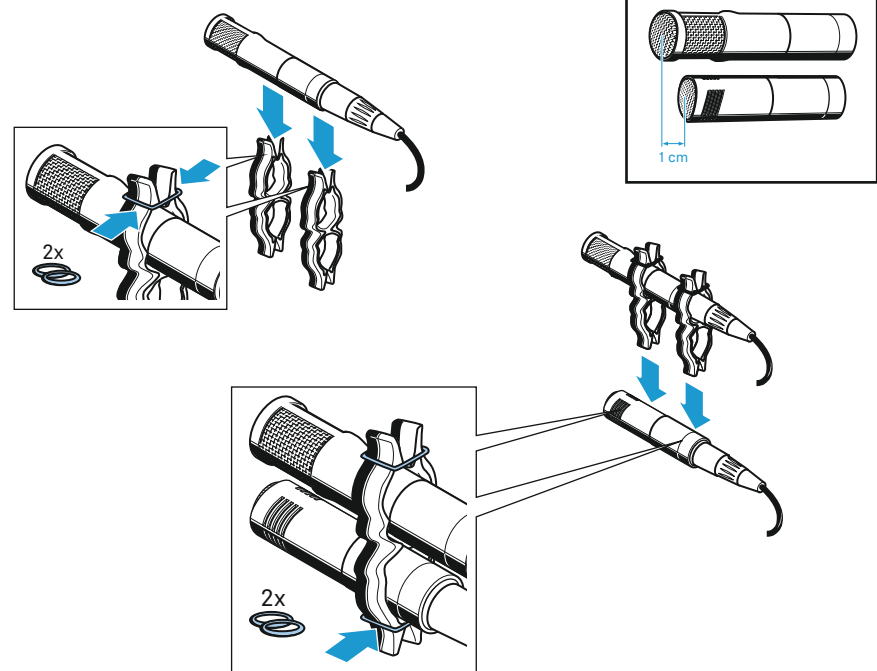
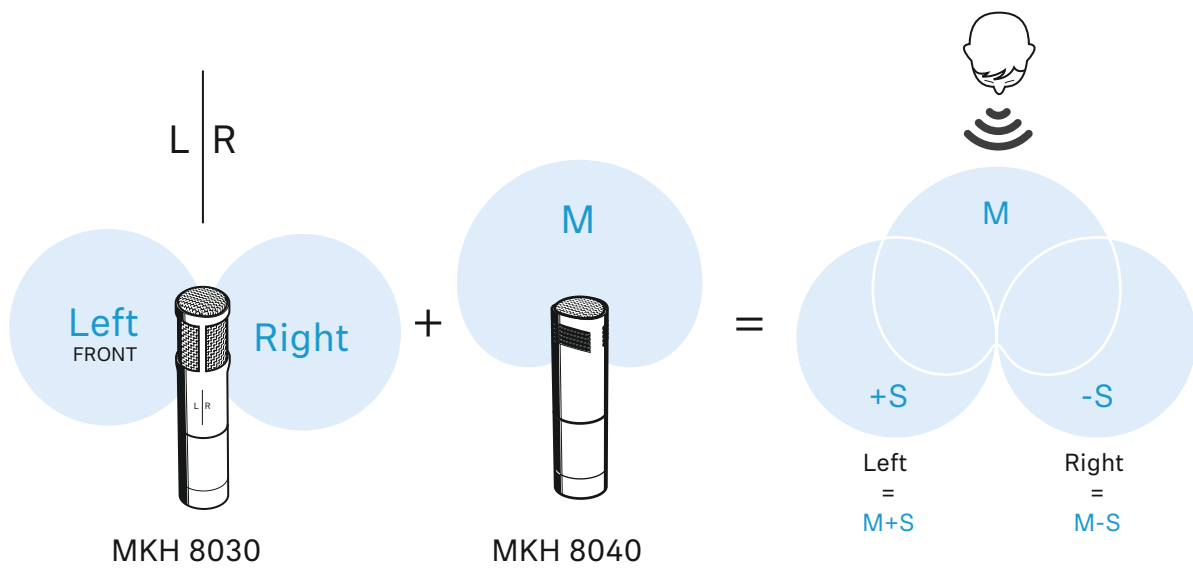

Polar pattern and frequency response

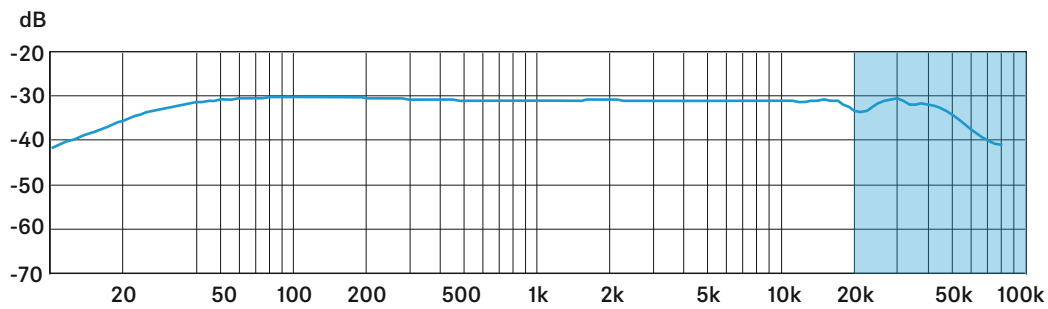
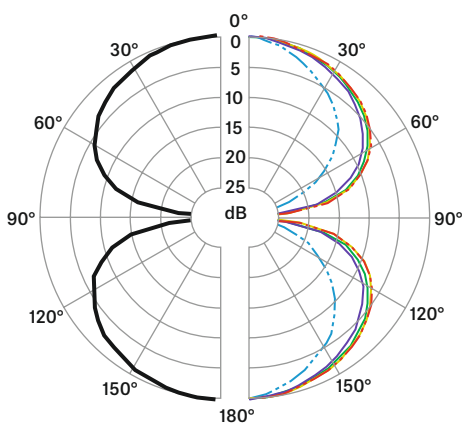

- 125 Hz
- 250 Hz
- 500 Hz
- 1,000 Hz
- 2,000 Hz
- 4,000 Hz
- 8,000 Hz
- 16,000 Hz
- 32,000 Hz

Specifications

Pick-up pattern	figure-of-eight
Frequency response	30 - 50,000 Hz
Sensitivity	-31 dBV/Pa (28 mV/Pa)
Max. SPL	139 dB
Equivalent noise level	13 dB(A) 21 dB (CCIR)
Phantom powering	48 V ± 4 V (P48, IEC 61938)
Current consumption	3.3 mA
Diameter	approx. 19 mm, max 21 mm
Length	approx. 59 mm with MZX 8000 approx. 93 mm
Weight	approx. 38 g with MZX 8000 approx. 70 g
Operating temperature	-10 °C to 60 °C (14 °F to 140 °F)
Storage temperature	-20 °C to 70 °C (-4 °F to 158 °F)
Relative humidity	5 to 95%, non-condensing

MKH 8000 Series

Microphone and accessories overview



MKH 8020
RF-condensor mic, omni



MKH 8030
RF-condensor mic, fig-of-eight



MKH 8040
RF-condensor mic, cardioid



MKH 8050
RF-condensor mic, super-cardioid



MKH 8090
RF-condensor mic, cardioid, wide cardioid

Delivery included accessories



MXZ 8000
XLR module



MZQ 8000
Mic clamp



MZW 8000 / MZW 8030
Foam windshield for
MZW 8030 for MKH 8030, all others: MZW 8000

Optional accessories



MZF 8000 II
Screw filter module MZF 8000 II at suitable place
between microphone head and XLR module.



MZL 8003
Connecting cable, 3 m



MZL 8010
Connecting cable, 10 m

Microphone stand



Microphone stand
Vertical bar & foot stand



MZE 8060 / MZE 8120
Extension tube 0.60 m / 1.20 m



MZGE 8000
Tube connector



MZEF 8060 / MZEF 8120
Vertical bar 0.60 m / 1.20 m



MZFS 8000
Floor stand

Table / Ceiling mounting



MZT 8000
Table stand



MZH 8042
Goose neck



MZH 8000
Ceiling mount



MZQ 8001
Mini clip



MZG 8000
Swivel joint



MZS 31
Shockmount

Shotgun microphones

Delivery included accessories



MKH 8060
RF-condensor mic, short shotgun



MKH 8070
RF-condensor mic, long shotgun



MXZ 8000
XLR module



MZW 8060 / MZW 8070
Foam windshield
MZW 8060 for MKH 8060
MZW 8070 for MKH 8070



MZQ 8060
Mic clamp

Optional accessories



MZF 8000 II
Screw filter module MZF 8000 II at suitable place
between microphone head and XLR module.



MZL 8003
Connecting cable, 3 m



MZL 8010
Connecting cable, 10 m



Outdoor use

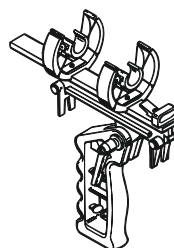

MZS 20-1
Pistol grip

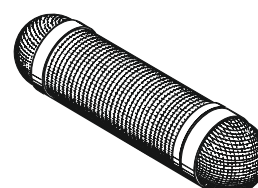

MZW 20-1 / MZW 80
short windshield basket / long windshield basket



MZH 20-1 / MZH 80
Wind muff for MZW 20-1 / for MZW 80