



AC 41

Active Antenna Combiner

Quick Guide

Kurzanleitung

Guide rapide

Guida rapida

Guía de inicio rápido

Guia rápido

Beknopte handleiding

Krótka instrukcja obsługi

Snabbguide

Kort vejledning

Pikaohje

Γρήγορος οδηγός

Kısa Kılavuz

Краткая инструкция

快速指南

快速使用指南

クイックガイド

퀵 가이드

SENNHEISER



www.sennheiser.com/download

Sennheiser electronic SE & Co. KG

Am Labor 1, 30900 Wedemark, Germany
www.sennheiser.com

Printed in Germany, Publ. 05/24, 578662/A04

AC 41

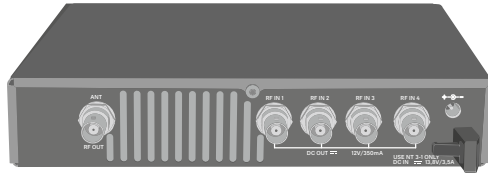

Operating elements

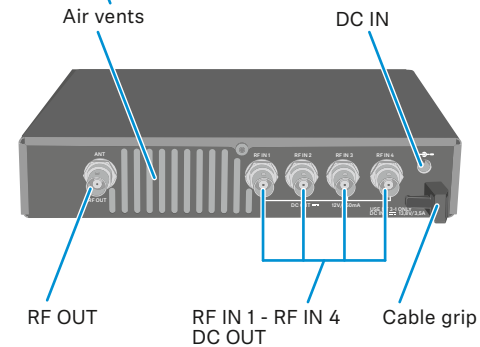
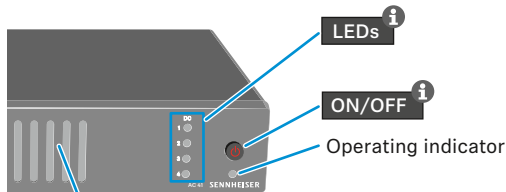

Setup

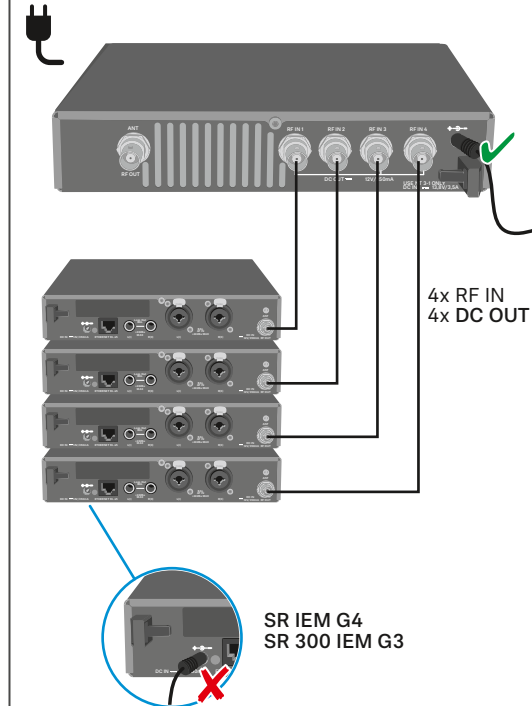
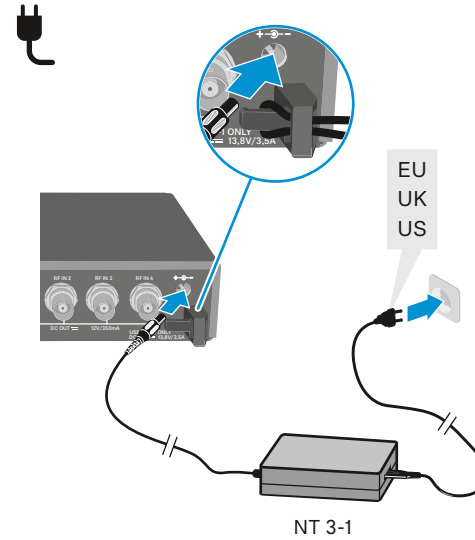
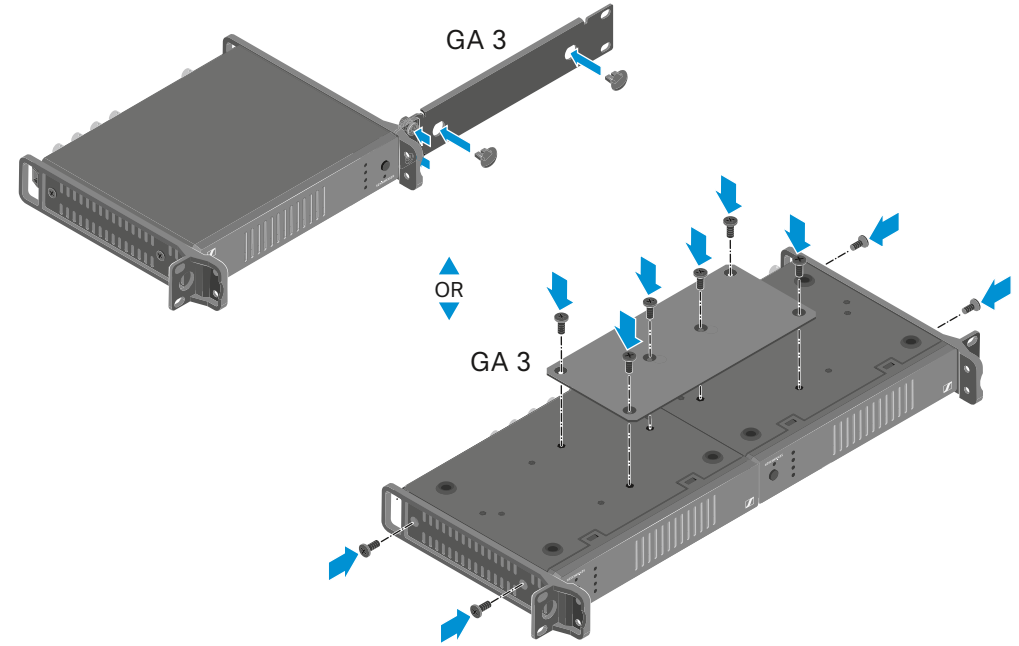

ON/OFF

ON/Standby

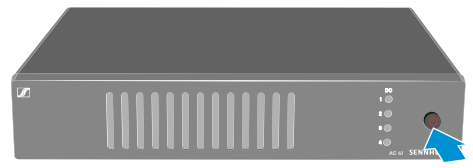

	AC 41	transmitter	LEDs
short	on	RF signal	on LEDs ⁱ
long	standby	off	off

OFF

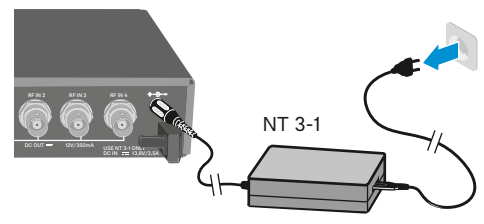

LEDs

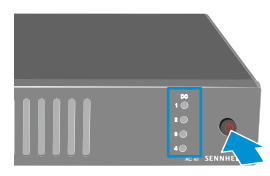

AC 41 = on

LEDs	DC to transmitters
on	✓
off	✗ →

Connecting devices

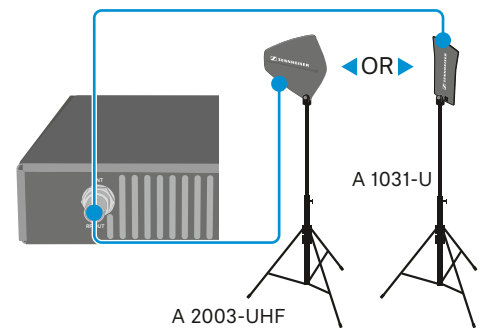

Remote antennas and maximum cable lengths → Instruction Manual

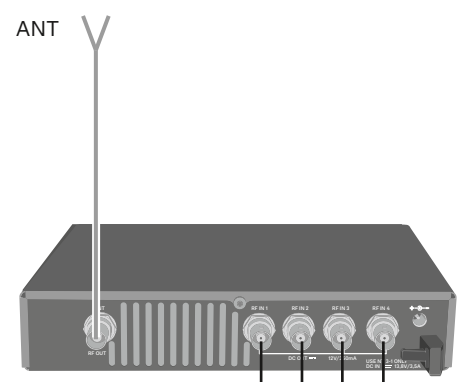

AC 41

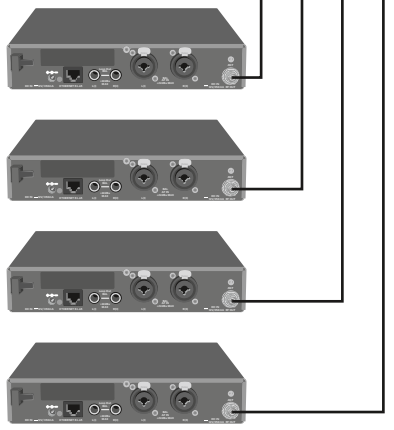

SR IEM G4
SR 300 IEM G3

Block diagram

